

380nm FP Butterfly Laser Diode

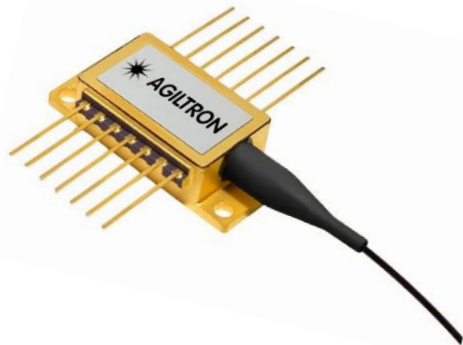

The 380nm series laser diodes are fabricated in a hermetically sealed 14-pin butterfly package. The laser diodes contain FP (Fabry-perot) Chip, thermoelectric cooler (TEC) and thermistor to secure high quality laser performance. The Laser Diodes Wavelength of 380±5nm, Output power: ≥1mW, Pigtail Type: 405-HP(Nufern) fiber with 900um loose tube, 1.0±0.1m, FC/APC connector. Our laser products are Telcordia GR-468 qualified, and in compliance with RoHS Directives.

Features

- High Output Power (≥ 1mW)
- Industry Standard 14-pin Butterfly Package
- High Performance
- RoHs
- Telcordia GR468

Specifications

Parameter	Min	Typical	Max	Unit
Center Wavelength	375	380	385	nm
Peak Optical Output Power	1			mW
Spectral Width		2		nm
Wavelength Temperature Coefficient (TEC Temperature at 15 to 35 °C)		0.3		nm/°C
Laser Forward Current (If)			300	mA
Laser Threshold Current (Ith)		100	200	mA
Laser Forward Voltage (Vf)		4.5	5.0	V
Laser Reverse Voltage (Vrpd)			2	V
Slope Efficiency	0.2	0.3	0.4	W/A
Operating Current		200	250	mA
Thermistor Current	10		100	µA
Thermistor Resistance (25°C)	9.5	10	10.5	KΩ
Thermistor Constant	3800		4100	K
TEC Voltage (Vtec)	-3.5		3.5	V
TEC Current (Itec)	-1.5		+1.5	A
TEC Capacity (ΔT)			50	°C
TEC Set Temperature (Ts)	15		35	°C
Operating Temperature (Top)	-20		60	°C
Storage Temperature (Ts)	-40		85	°C
Fiber Type	405-HP (Nufern)			
Pigtail Type	900µm loose tube			
Reliability	Telcordia 468			

Applications

- Test
- Communication
- Instrument
- Fiberoptic sensors
- Laser sources

Note: The specifications provided are for general applications with a cost-effective approach. If you need to narrow or expand the tolerance, coverage, limit, or qualifications, please [click this link](#):



Warning: The device can be damaged by a spike in applying voltage. Do not touch by hand or use a regular power supply. The device mounted on PCB is a cost-effective OEM module for professional system integration only, not intended for laboratory use, which be a protected turn-key boxed package. Information is believed to be accurate and is subject to change without notice. Some specific combinations of options may not be available. The user assumes all risks and liability in connection with the use of a product or its application.

Rev 11/18/24

380nm FP Butterfly Laser Diode

DATASHEET

Mechanical Dimensions (mm)

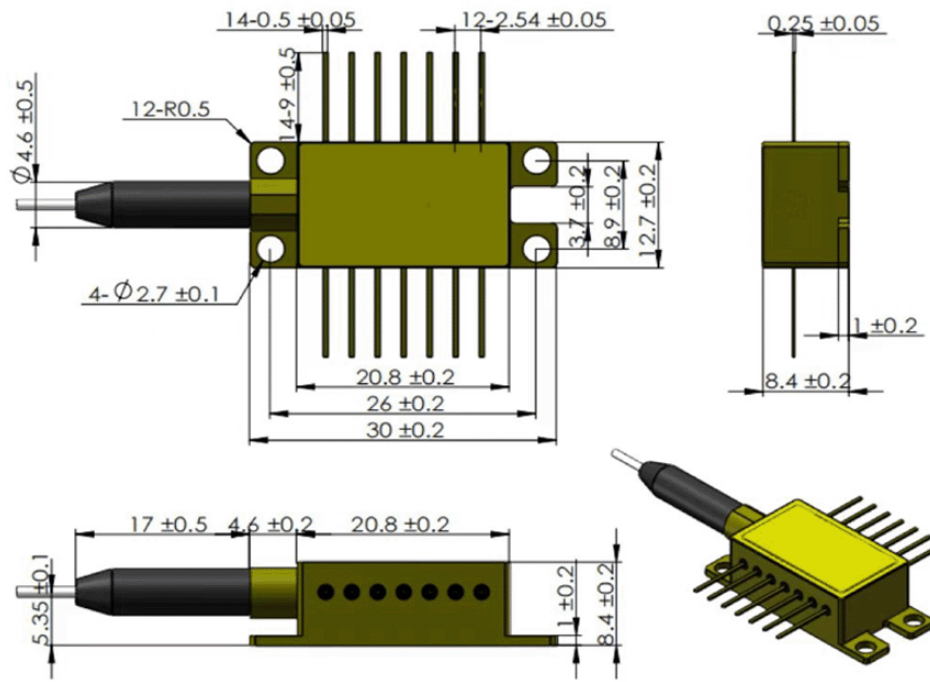

*Product dimensions may change without notice. This is sometimes required for non-standard specifications.

Electrical Connection

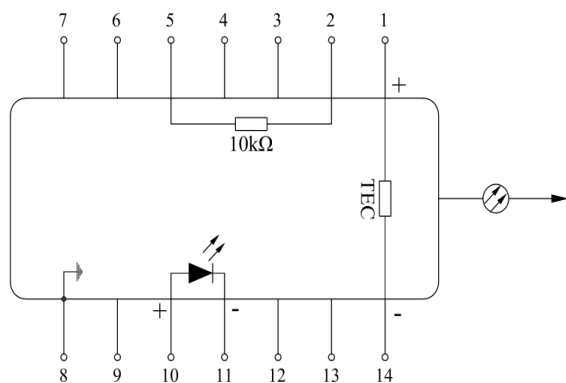

PIN	Description	PIN	Description
1	TEC (+)	8	Case Ground
2	Thermistor	9	NC
3	NC	10	LDA (+)
4	NC	11	LDC (-)
5	Thermistor	12	NC
6	NC	13	NC
7	NC	14	TEC (-)

380nm FP Butterfly Laser Diode



DATASHEET

Typical Spectrum

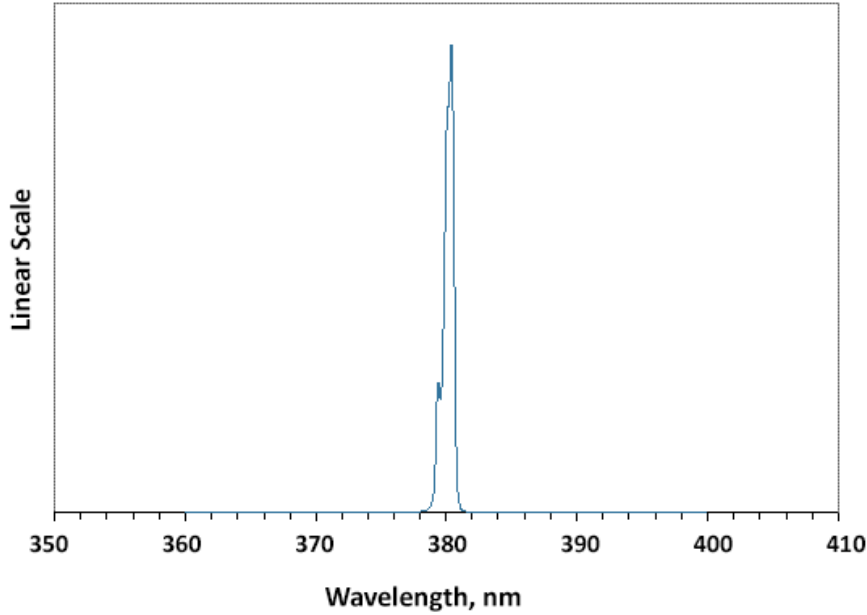

Ordering Information

Prefix	Wavelength	Output Power	Linewidth	TEC Cooling	Package	Fiber Type	Fiber Buffer	Fiber Length	Connector
FLBF-	380nm = 38 Special = 0	1mW = 1 5mW = 5 10mW = A 20mW = B 40mW = D 60mW = E 80mW = H Special = 0	2nm = 1 Special = 0	Yes = 1	Type 1 = 1	SM400 = 4 PM400 = A Special = 0	900µm Tube = 3 Special = 0	1m = 1 Special = 0	FC/APC=3 Special = 0

380nm FP Butterfly Laser Diode

DATASHEET

Benchtop Matching Laser Diode Driver



Agiltron cost-effective LDCB series benchtop control kit is designed for easy laser diode mounting and precise control. It incorporates a high-precision, low-noise auto-feedback drive electronics to ensure constant output power or a constant driving current and an integrated temperature control unit maintains optimal operating conditions. The system provides up to 1A driving current and up to 2A TEC cooling current. Each system features a front fiber output connector. The user interface includes an intuitive LCD display for independent control of output power and temperature via two front rotating knobs. The LDCB also includes a universal power supply compatible with 100 to 240 VAC. The LDCB has a built-in isolator option to prevent reflection-induced laser emissions instability. The LDCB is designed as a laser diode and TEC controller kit for customer to install laser diode. It has three types of pluggable laser mounts of butterfly, DIL, and TOCAN. The TOCAN mount contains an external TEC that maintains a constant temperature for wavelength stability.

For details please click: <https://agiltron.com/product/laser-diode-tec-controllers-benchtop-kit/>

Turn-Key Module Matching The Laser Diode



The Agiltron LDCM series laser source module is designed for OEM applications and features all-in-one high reliability and highly stable laser output. The LDCM contains high-precision, low-noise, auto-feedback laser diode drive electronics to ensure constant output power or driving current and an integrated temperature controller that maintains optimal operating conditions. An optional fiber optical isolator can be integrated to prevent reflection-induced laser emission instability, which is essential for achieving highly stable lasers. Agiltron produces isolators from 370nm to 2600nm. The system provides up to 1A driving current and up to 2A TEC cooling current. Each unit features a single FC/APC connector output and two front rotating knobs for independent setting of laser output power and temperature. A toggle switch allows selection between constant current control mode and feedback constant output power mode.

For details please click: <https://agiltron.com/product/laser-diode-tec-controllers-module/>

Laser Driver Kit



Agiltron cost-effective LDCD series module control kit is designed for easy laser diode mounting and precise control. It incorporates a high-precision, low-noise auto-feedback drive electronics to ensure constant output power or a constant driving current and an integrated temperature control unit maintains optimal operating conditions. The system provides up to 1A driving current and up to 2A TEC cooling current. It has three types of pluggable laser mounts of butterfly, DIL, and TOCAN. The TOCAN mount contains an external TEC that maintains a constant temperature for wavelength stability. It comes with cables to connect between the mounting module to the driving module, making integration convenient.

For details please click: <https://agiltron.com/product/laser-diode-tec-controllers-compact/>

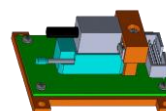
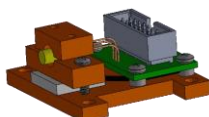
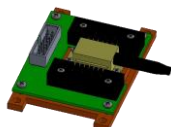

380nm FP Butterfly Laser Diode

DATASHEET

Caution Electrostatic Sensitivity



- Never touch laser diode and the module using hands
- Always use protections when handle a laser diode
- Recommend mounting the laser diode using an ionic gun and ESD finger cots



Laser Safety

This product meets the appropriate standard in Title 21 of the Code of Federal Regulations (CFR). FDA/CDRH Class 1M laser product. This device has been classified with the FDA/CDRH under accession number 0220191. All versions of this laser are Class 1M laser products, tested according to IEC 60825-1:2007 / EN 60825-1:2007. An additional warning for Class 1M laser products. For diverging beams, this warning shall state that viewing the laser output with certain optical instruments (for example eye loupes, magnifiers, and microscopes) within a distance of 100 mm may pose an eye hazard. For collimated beams, this warning shall state that viewing the laser output with certain instruments designed for use at a distance (for example telescopes and binoculars) may pose an eye hazard.

Wavelength = 1.3/1.5 μm .

Maximum power = 30 mW.



*Caution - Use of controls or adjustments or performance of procedures other than those specified herein may result in hazardous radiation exposure.

*IEC is a registered trademark of the International Electrotechnical Commission.